

English

NSK

Micromotor for Laboratory Work


ULTIMATE XL-K/D

OPERATION MANUAL



Thank you very much for purchasing ULTIAMTE XL-K/D.
Please read this Operation Manual carefully regarding the instructions for use, handling method, and maintenance and inspection prior to use and store it in a place where users can review it anytime.

Contents

 IMPORTANT INSTRUCTIONS AND WARNING	1
1. Component Names	5
2. Set up of Control Unit	6
3. Operation Procedure	7
4. Speed limit mechanism	8
5. Operation Procedure of Air Turbine (Option)	8
6. Protective Circuit	8
7. Memory Function	9
8. Error Code	9
9. Replacement of Fuse	10
10. Maintenance Mode	10
11. Vacuum-coupled Mode	11
12. Handling of Motor and Handpiece	12
13. Handpiece Stand	14
14. Specification	14
15. Troubleshooting	15
16. Disposing Product	18

IMPORTANT INSTRUCTIONS AND WARNING - Electric Devices



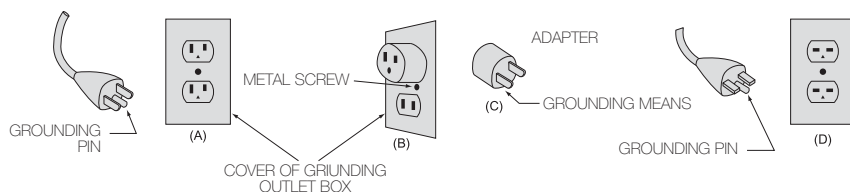
WARNING!

When using electric tools, basic safety precautions should always be followed to reduce the risk of fire, electrical shock and personal injury, including the following. Read all these instructions before operating this product and save these instructions.

A. GROUNDING INSTRUCTIONS

1. In the event of a malfunction or breakdown, grounding provides a path of least resistance for electric current to reduce the risk of electric shock. This tool is equipped with an electric cord having an equipment-grounding conductor and a grounding plug. The plug must be plugged into a matching outlet that is properly installed and grounded in accordance with all local codes and ordinances.
2. Do not modify the plug provided - if it will not fit the outlet, have the proper outlet installed by a qualified electrician.
3. Improper connection of the equipment-grounding conductor can result in a risk of electric shock. The conductor with insulation having an outer surface that is green with or without yellow stripes is the equipment-grounding conductor. If repair or replacement of the electric cord or plug is necessary, do not connect the equipment grounding conductor to a live terminal.
4. Check with a qualified electrician or service personnel if the grounding instructions are not completely understood, or if in doubt as to whether the tool is properly grounded.
5. Use only 3-wire extension cords that have 3-prong grounding plugs and 3-pole receptacles that accept the tool's plug.
6. Repair or replace damaged or worn cord immediately.
7. This tool is intended for use on a circuit that has an outlet that looks like the one illustrated in Sketch A in Figure (below) (120V). The tool has a grounding plug that looks like the plug illustrated in Sketch A in Figure (below). A temporary adapter, which looks like the adapter illustrated in Sketches B and C, may be used to connect this plug to a 2-pole receptacle as shown in Sketch B if a properly grounded outlet is not available. The temporary adapter should be used only until a properly grounded outlet can be installed by a qualified electrician. The green-colored rigid ear, lug, and the like, extending from the adapter must be connected to a permanent ground such as a properly grounded outlet box.

Grounding Method



8. USE PROPER EXTENSION CORD. Make sure your extension cord is in good condition. When using an extension cord, be sure to use one heavy enough to carry the current your product will draw. An undersized cord will cause a drop in line voltage resulting in loss of power and overheating. Table (below) shows the correct size to use depending on cord length and nameplate ampere rating. If in doubt, use the next heavier gauge. The smaller the gauge number, the heavier the cord.
9. Install equipment so that the power supply cord can be pulled out without hindrance in event of emergency.

Minimum gauge for cord

Ampere Rating		Volts	Total Length of cord			
			7.5m (25ft.)	15m (50ft.)	30m (100ft.)	45m (150ft.)
More Than	Not More Than	Cord Number				
0	6	120V	7.5m (25ft.)	15m (50ft.)	30m (100ft.)	45m (150ft.)
6	10	240V	15m (50ft.)	30m (100ft.)	60m (200ft.)	90m (300ft.)
10	12		#18	#16	#16	#14
12	16		#18	#16	#14	#12
			#16	#16	#14	#12
			#14	#12	Not Recommended	

B. OTHER WARNING INSTRUCTIONS

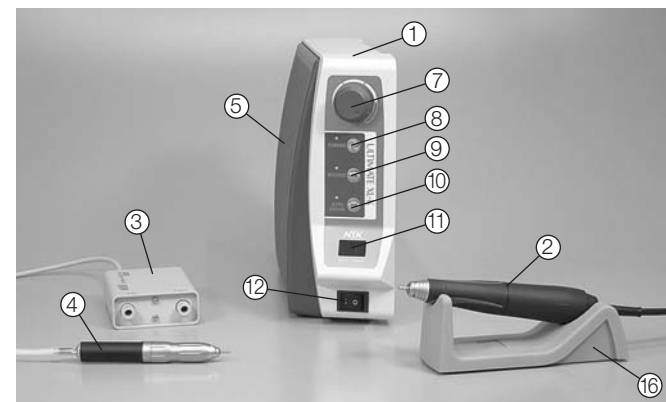
1. For your own safety read instruction manual before operating tool.
2. Wear eye protection.
3. Replace cracked wheel immediately.
4. Always use guards and eye shields.
5. Do not over tighten wheel nut.
6. Use only flanges furnished with the grinder.
7. REMOVE ADJUSTING KEYS AND WRENCHES. From habit of checking to see that keys and adjusting wrenches are removed from tool before turning it on.
8. KEEP WORK AREA CLEAN. Cluttered areas and benches invite accidents.
9. DON'T USE IN DANGEROUS ENVIRONMENT. Don't use power tools in damp or wet locations, or expose them to rain. Keep work area well lighted.
10. Risk of injury due accidental starting. Do not use in an area where children may be present.
11. DON'T FORCE TOOL. It will do the job better and safer at the rate for which it was designed.
12. USE RIGHT TOOL. Don't force tool or attachment to do a job for which it was not designed.
13. WEAR PROPER APPAREL. Do not wear loose clothing, gloves, neckties, rings, bracelets, or other jewelry that might get caught in moving parts. Nonslip footwear is recommended. Wear protective hair covering to contain long hair.
14. ALWAYS USE SAFETY GLASSES. Everyday eyeglasses only have impact resistant lenses, they are NOT safety glasses. Also use face or dust mask if cutting operation is dusty.
15. SECURE WORK. Use clamps or a vise to hold work when practical. It's safer than using your hand and it frees both hands to operate tool.
16. MAINTAIN TOOLS WITH CARE. Keep tools sharp and clean for best performance and to reduce the risk of injury to persons. Follow instructions for lubricating and changing accessories.

17. DISCONNECT TOOLS before servicing; when changing accessories, such as blades, bits, cutters, and like.
18. REDUCE THE RISK OF UNINTENTIONAL STARTING. Make sure switch is in off position before plugging in.
19. USE RECOMMENDED ACCESSORIES. Consult the owner's manual for recommended accessories. The use of improper accessories may cause risk of injury to persons.
20. NEVER LEAVE TOOL RUNNING UNATTENDED. TURN POWER OFF. Don't leave tool until it comes to a complete stop.
21. For recommended operating speed for various applications, please follow the instructions of bur manufacturers.
22. The system functions normally in the environment where the temperature is at 0-40°C, humidity at 10-85% RH, atmospheric pressure at 500-1060hPa, and no moisture condensation in the Unit. Use at outside of these limits may cause malfunction.
23. Store the system in the place where the temperature is at -10-60°C, humidity at 10-85% RH, atmospheric pressure at 500-1060hPa, and the system is not subject to air with dust, sulfur, or salinity.
24. Severe shock – Eg. Dropping Control Unit, or the Micromoto – may cause damage.
25. Do not turn the bur lock Chuck Control Ring while the handpiece is rotating.
26. Do not rotate the motor when the bur lock Chuck Control Ring is at OPEN position, or a bur is not mounted in the chuck. It may cause the motor/handpiece disconnection or sudden heat generation.
27. Activation of Circuit Breaker means too much load is applied to the motor beyond the capacity the motor takes. This circuit breaker is designed to protect the motor, but it is desired to perform the grinding work without activating the circuit breaker.
28. Care should be taken not to drop micromotor handpiece on floor or hard work surface in order to avoid damage caused by impact shock.

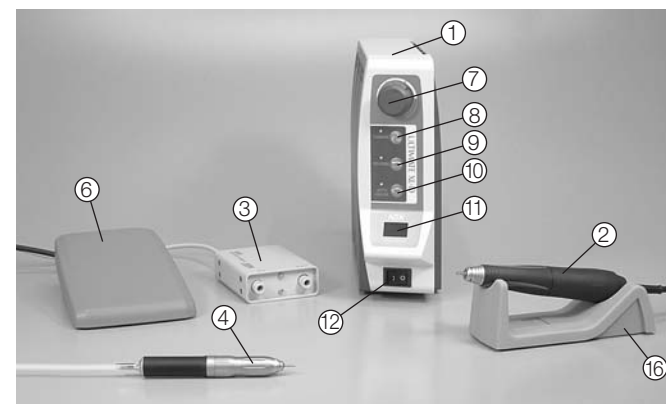
C. Important Instructions and Warning on ULTIAMTE XL-K/D

No lubrication is required to either motor or handpiece because ball bearings impregnated with grease in both motor and handpiece.

1. Component Names



ULTIMATE XL-K



ULTIMATE XL-D

- | | |
|-------------------------------------|--|
| ① Control Unit | ⑩ Auto Cruise Switch |
| ② Motor Handpiece | ⑪ Indicator |
| ③ Turbine Adapter (option) | ⑫ Power Switch |
| ④ Air Turbine (option) | ⑬ Motor Connector |
| ⑤ Knee Controller (Ultimate XL-K) | ⑭ Turbine Adapter Connector |
| ⑥ Pedal | ⑮ Fuse Box |
| ⑦ Speed Control Knob | ⑯ Handpiece Stand |
| ⑧ Turbine / Motor Selector Switch | ⑰ Foot Pedal Connector (Ultimate XL-D) |
| ⑨ Forward / Reverse Selector Switch | |

2. Set up of Control Unit

1. Mounting of the Unit

(1) ULTIMATE XL-K

Bore a hole while aligning the attached template with the inside of the right side of the technical desk. Then, mount a bracket with the attached screw and nut, and mount the unit by inserting the bracket lug into the opening at the back of the unit. (Fig. 1)



Fig.1

(2) ULTIMATE XL-D (Option)

ULTIMATE XL-D is used by standing it on a work bench, but it can be used by mounting it by use of the optional bracket if there is a wall at right side of the technical desk. If the unit is to be mounted on the bracket, remove the two cover-mounting screws. (Fig. 2)



Fig.2

2. Mounting of the Motor

Insert the motor cord plug locator into ⑬ Motor Connector aligning it with the groove of the connector, and tighten the motor cord plug nut to fix. (Fig. 3)



Fig.3

3. Connecting of the Power Cord

Securely insert the plug of Power Cord into connector at the back of the unit aligning it with the configuration. (Fig. 4)



Fig.4

4. Mounting of the Foot Pedal (ULTIMATE XL-D)

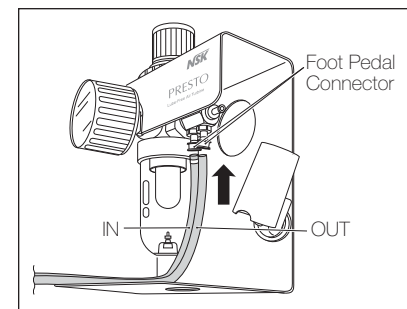
Insert the foot pedal plug into the ⑰ Foot Pedal Connector at the back of the unit.

5. Mounting of the Air Turbine (Option)

Insert the plug of the Turbine Adapter into the ③ Turbine Adapter Connector at the back of the unit. Insert two hoses from the ③ Turbine Adapter into the openings for foot pedal connection in the air line kit. (Fig. 5)

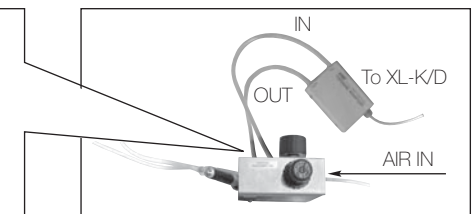


Fig.5



Foot Pedal Connector

Fig.6



3. Operation Procedure

1. Connect the power cord to outlet.
2. Make sure that the ⑦ Speed Control Knob is at the lowest position (position reached by fully turning counterclockwise)
3. Turn the ⑫ Power Switch. The preset rotation speed will appear on the Indicator.
4. Select the rotation direction with ⑨ Forward/Reverse Selector Switch. Each time this switch is pressed, the direction changes between FORWARD and REVERSE.
5. Preset the maximum rotation speed with the ⑦ Speed Control Knob.
6. Depress the ⑤ Knee Controller for ULTIMATE XL-K and the ⑥ Pedal for ULTIMATE XL-D, and the motor will run. The rotation speed can be variably controlled within the preset maximum rotation speed range according to the degree of depression of the ⑤ Knee Controller or the ⑥ Pedal.

※Auto cruise mechanism

To fix the speed within the rotation speed range set by the volume with the ⑦ Speed Control Knob, press the ⑩ Auto Cruise Switch while the motor is at rest. The display lamp, which is next to the switch, will light up. If the desired speed is set with the ⑤ Knee Controller or the ⑥ Pedal and a uniform speed can be maintained for one second, the motor will continue running at the desired speed if the ⑤ Knee Controller or the ⑥ Pedal is released. To cancel it, depress the ⑤ Knee Controller or the ⑥ Pedal again or press ⑩ Auto Cruise Switch again.

4. Speed limit mechanism

For the use of a small-diameter round bur or fisher bur at 40,000min⁻¹(rpm) or more, pressing the Speed Limit Release Button, which is equipped with the ⑦ Speed Control Knob, and turning the speed control knob allows a setting of up to 50,000min⁻¹(rpm). (Fig.7)



Fig. 7

⚠ CAUTION

Use of 40,000min⁻¹(rpm) or more is allowable only when the bur manufacturer or dealer specifies that the bur's acceptable rotation speed is 40,000min⁻¹ (rpm) or more. If the use of more than the acceptable rotation speed is made, the bur may be broken.

5. Operation Procedure of Air Turbine (Option)

1. Push the ⑧ Turbine/Motor Selector Switch, and the green lamp will light up and the air turbine will be selected.
2. • When the auto cruise mechanism is OFF :
Depress the ⑤ Knee Controller or the ⑥ Pedal, and the turbine will rotate.
• When the auto cruise mechanism is ON:
Push the ⑩ Auto Cruise Switch and depress the ⑤ Knee Controller or the ⑥ Pedal, and after a lapse of two seconds, the turbine will continue rotating even if the ⑤ Knee Controller or the ⑥ Pedal is released.
3. To cancel the auto cruise mechanism, depress the ⑤ Knee Controller or the ⑥ Pedal again or push the ⑩ Auto Cruise Switch.
※ Even if ⑨ Forward/Reverse Selector Switch is pushed while using the air turbine, it will be neglected only with the beeps of electronic sounds.
4. Push the ⑧ Turbine/Motor Select Switch again, and the lamp will go out and the motor will be available.

6. Protective Circuit

When the motor is operated with a load exceeding the limit or the handpiece is in an unrotatable condition, the circuit to protect the motor and unit operates to stop the power supply to the motor, whereby an error code appears on the ⑪ Indicator.

How to reset the protective circuit

It can be reset by depressing the ⑤ Knee Controller or ⑥ Pedal again after eliminating the cause of the error.

7. Memory Function

When the ⑫ Power Switch is turned on, the rotation direction made when the switch was last turned off are restored. Special attention should be given to the rotation direction.

8. Error Code

When the motor is stopped due to some trouble such as a failure, overload, wire breakage or misuse, Speed Display displays the error code for checking the status of the unit and understanding the cause of the trouble easily.

Error cord	Description	Cause
E0	Self-check error	<ul style="list-style-type: none"> • Abnormal internal memory • Broken internal memory
E1	Overcurrent detection error (Hard)	<ul style="list-style-type: none"> • Long-time use at a high load (overcorrect) • Shorted cord (power line) • Shorted motor winding • Failure of a turbine adapter
E2	Overvoltage detection error	<ul style="list-style-type: none"> • Shorted cord (power line), damaged circuit • Broken internal circuit • Failure of a turbine adapter
E3	Motor sensor error	<ul style="list-style-type: none"> • Faulty sensor (Hall IC) in the motor • Disconnected motor cord • Severed cord (signal line) • Open chuck • Faulty handpiece • If the cord of the turbine adapter is loosed.
E4	Unit overheat error	<ul style="list-style-type: none"> • Temperature rise in the unit due to longtime use at a high load • Unit placed under high temperature
E5	PAM circuit error	<ul style="list-style-type: none"> • Abnormal voltage generated in start / stop circuit • Faulty start / stop circuit from PAM (L Slide)
E6	Rotor lock error	<ul style="list-style-type: none"> • Open chuck • Faulty handpiece • Motor Faulty • Faulty sensor (Hall IC) in the motor • Severed cord (signal, power line)
E8	Overvoltage detection error (Soft)	<ul style="list-style-type: none"> • Long-time use at a high load (overcorrect) • Shorted cord (power line) • Shortstop of the motor winding • Failure of a turbine adapter
E9	ITRIP error	Faulty motor and circuit
EF	Foot pedal error	<ul style="list-style-type: none"> • Faulty Foot Pedal or Shorted Foot Pedal cord • Broken internal circuit

For countermeasures against error displays, see the section on 15.Troubleshooting.

9. Replacement of Fuse

Fuse is located in ⑮ Fuse Box. Release ratchet clamp located on the top and bottom of the ⑮ Fuse Box and pull it out to change the fuse (T3.15AL250V). (Fig. 8)

When the fuse come down, Insert new fuses (T3.15AL250V) into the ⑮ Fuse box and then push the ⑮ Fuse box into the original position until hearing a sound click.



Fig.8

- Fuse: Order No. (120V) : 12001-31510

- Fuse: Order No. (230V) : 12001-16010

⚠ CAUTION

Fuse is burned out when a short circuit occurs or when over-voltage is flowed into the primary current source. If the cause is uncertain, return the product to an authorized NSK's service shop for inspection.

10. Maintenance Mode

The unit is provided with a maintenance mode to check the functionality of the switches, display, foot pedal, motor, etc. While pressing ⑧ Turbine/Motor Selector Switch and ⑩ Auto Cruise Switch at the same time, turn on the Power Switch and keep pressing the button until beeps are made (for about 2 seconds). At this time, turning the volume from the minimum position in order displays "oP", "dP", "HL", "Pd" and "in", allowing the following checks. To release Maintenance Mode, turn Power Switch off and switch on again.

(1) "oP": Switch check (operation check)

Press the switches on the panel, and the right and/or left lamps will light to check to see if the switches operate normally.

(2) "dP": Display check

Press ⑨ Forward/Reverse Selector Switch, and the lamps will light one by one to check to see if they operate normally. To cancel this check, press ⑨ Forward/Reverse Selector Switch again.

(3) Motor signal check (Hall IC check)

Press ⑨ Forward/Reverse Selector Switch, and ⑪ Indicator will indicate one or two horizontal lines. Turn the motor slowly by hand, and this display will change to one line, two lines, one line, two lines, smoothly from the top to bottom or from the bottom to top. If any one of the three lines does not light, the sensor (Hall IC) in the motor is faulty or the cord is severed, therefore repair is needed. To cancel this check, press ⑨ Forward/Reverse Selector Switch again.

Eg. 2 → 3 → 4 → ~ A → b → C → d → C → b → A ~ 4 → 3 → 2

(4) "Pd": Knee Controller or Foot pedal check

Press ⑨ Forward/Reverse Selector Switch, and ⑪ Indicator will change. During normal time, Indicator changes in hexadecimals (0~9, A~F) according to the amount of depressing ⑤ Knee controller or ⑥ Pedal. Also, depressing the pedal slightly lights LED, and depressing it fully extinguishes the lamp. If ⑪ Indicator does not change smoothly or LED does not light properly, ⑤ Knee controller or ⑥ Pedal may be faulty. To cancel this check, press ⑨ Forward/Reverse Selector Switch again.

(5) "in": Initializing function

Press ⑨ Forward/Reverse Selector Switch, and beeps will be made and rotation direction, other settings will return to the factory set condition.

Rotation direction: FWD (forward)
Vacuum-coupled mode: OFF
Motor/Turbine: Motor
AUTO Cruse: OFF

11. Vacuum-coupled Mode

On some dental tables with vacuum dust collector, the motor may be used while being coupled with a dust collector. When such a dust collector * is used, power consumption of ULTIMATE XL-K/D can be regulated so that the vacuum-coupled function can work. If you need coupling with a vacuum dust collector, select the mode as follows:

How to select the mode

While pressing ⑨ Forward/Reverse Selector Switch, turn on ⑫ Power Switch, and the mode can be selected. A long beep indicates vacuum-coupled mode and 2 short beeps indicate non-coupled (energy-saving) mode.

* Each time the switch selection is made, the mode changes between vacuum-coupled mode and non-coupled mode.

* A currently known dust collector is KAVO EWL-560.

12. Handling of Motor and Handpiece

(1) Insertion or Removal of Bur

The chuck is opened by turning the Chuck Control Ring to an open position. The chuck is loosened and the bur can be removed. By turning the Chuck Control Ring in the LOCK direction, the chuck is closed and the bur can be mounted. At this time, turn the ring until it clicks. (Fig. 9)

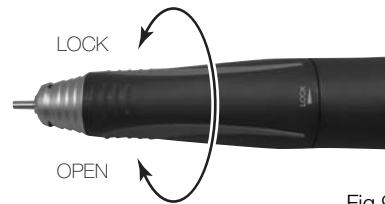


Fig.9

CAUTION

- Do not turn the Ring during motor rotation.
- Do not turn a motor, when it has not attached bur or the Ring Open position. It may be reasons for the failure or overheating of the handpiece.

(2) Cleaning and Replacement of Chuck

(1) Removal of Chuck

To remove the chuck, open the Chuck Control Ring and turn the chuck counterclockwise with the provided spanner wrench. (Fig. 10)

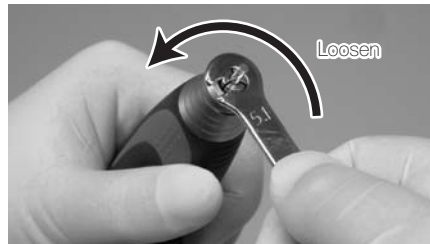


Fig.10

* If a bur having a large diameter of a cutting part is used under a high torque, the chuck may rotate in the close direction and the bur may be stuck and cannot be removed. In this case, align the nose's slit and spindle's spanner position (flat part), and apply an L spanner to fix the spindle. Open the Chuck Control Ring and turn the chuck counterclockwise with the provided spanner wrench to remove it. (Fig. 11)



Fig.11

(2) Cleaning of Chuck

To keep accuracy for the Chuck remove and clean the chuck as frequently as possible in the ultrasonic cleaner. Clean at least once a week.

CAUTION

Neglecting to clean the chuck for a long time is very dangerous because wax, gypsum, etc., accumulate in the chuck and the bur is caught insecurely, causing runout.

(3) Insertion of Chuck

Thinly apply oil before insertion. Open the Chuck Control Ring, insert the dummy bur or the bur in use into the chuck, and turn the chuck clockwise by hand until it stops. Then, lock the Chuck Control Ring, and the chuck could hold the bur securely. (Fig. 12)



Fig.12

CAUTION

Before using the handpiece, make sure to pull the rotating instrument (bur, etc.) to check that it is securely mounted.

3. Disconnecting and Connecting of Motor Cord to Motor

Remove the cord nut at the rear end of the motor, and the motor cord connector can be pulled out. For connection, align the connector pin and the hole in the motor cord connector, and insert the connector straight until it stops. Then, tighten the cord nut. (Fig.13)

* When inserting the connector, do not turn or twist it.



Fig.13

4. Disconnecting Handpiece from Motor

The handpiece and motor are screwed at the midpoint. Firmly grasp the motor outer case and the handpiece outer case and turn it counterclockwise to disconnect. (Fig. 14).



Fig.14

CAUTION for Handpiece connection

When connecting the handpiece to the motor, turn the handpiece clockwise and tighten firmly. If the clutch is not engaged properly, the handpiece cannot be tightened completely. In such case, Do Not Force. Loosen the handpiece and turn the bur briefly to re-position the drive dog. Reconnect the handpiece and tighten securely. (Fig. 15)

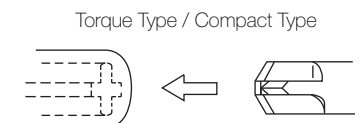


Fig.15

13. Handpiece Stand

At the bottom of the handpiece stand, tools necessary for handpiece maintenance and a spare chuck (optional) can be mounted.
(Fig. 16)



Fig. 16

14. Specification

Control Unit

Model	Ultimate XL-K	NE231
	Ultimate XL-D	NE232
Power supply	AC120V 50/60 Hz 46VA	
	AC230V 50/60 Hz 46VA	
Weight	Ultimate XL-K	3.2kg
	Ultimate XL-D	3.3kg
Model	Ultimate XL-K	W90 × D270× H230 mm
	Ultimate XL-D	W81 × D270× H230 mm

Food Pedal

Model	FC-64
Weight	460g

Handpiece Stand

Model	Handpiece Stand
Weight	120g

Motor Handpiece

1) Torque Type

Model	UMXL-T(P) 2M
Speed	1,000~50,000 min ⁻¹
Max. Torque	8.7N·cm
Weight	215g (exclude the code)
Dimensions	L151 × ø29mm
Code Length	2.0m

2) Compact Type

Model	UMXL-C 2M
Speed	1,000~50,000 min ⁻¹
Max. Torque	6 N·cm
Weight	181g (exclude the code)
Dimensions	L144 × ø27mm
Code Length	2.0m

15. Troubleshooting

Please check the following points before sending back instruments for repair.

<Unit / Motor>

Trouble		Cause / Check	Remedy
Pilot Lamp does not light		The power plug is disconnected.	Insert the power plug correctly.
		The fuse is blown.	Replace it with a specified fuse. If the reason the fuse has blown is unknown, ask for an inspection.
		Power Switch is faulty.	Ask for repair.
Control Unit display “—” and “Setting Rotation Speed” alternately.		Power on the Control Unit within pressing the Foot Pedal.	Power on the Control Unit without pressing the Foot Pedal. When it does not work definitely, take off the Foot Pedal cord plug from the Control Unit and Power it on. If it does not operate correctly, ask for your dealer. Even after you tried above and the Control Unit could not operate normally, contact your dealer for repair.
The motor and handpiece do not run, or Reset Lamp lights.	No error code indication	The connection of the foot control cord plug is loose.	Connect the foot control cord plug correctly.
		Maintenance mode (4) “Pd”: Check to see if the foot control operates normally.	If the foot control does not operate normally, ask for repair of the foot control or replace it with a new one.
	Error code E0 appears.	Turn on the power again.	If the same error code appears, ask for repair of the unit.
	Error code E1 appears.	Turn on the power again.	If it operates normally, the error display is temporarily due to overload, which is not a problem.
		If you have two or more units, replace the motor and the motor cord and check the operation.	If it operates normally after replacing the motor and the motor cord, the motor and/or the motor cord may be shorted. Ask for repair of the motor and/or the motor cord. If the same error code still appears after replacing, ask for repair of the unit.
	Error code E2 appears.	The motor cord is disconnected.	Connect the motor cord correctly.
If you have two or more units, replace the motor and the motor cord and check the operation.		If it operates normally after replacing the motor and the motor cord, the motor and/or the motor cord may be severed. Ask for repair of the motor and/or the motor cord. If the same error code still appears after replacing, ask for repair of the unit.	

Trouble	Cause/Check	Remedy
Error code E3 appears.	The motor cord is disconnected.	Connect the motor cord correctly.
	Maintenance mode (3) "HL": Confirm whether you work by a motor signal check normally.	If any problem is found during a check, the motor cord may be severed or the sensor in the motor may be faulty. Ask for repair.
	The chuck is open.	Lock the chuck.
	Check turning a tip with a finger lightly and turning around it lightly.	If the rotation is abnormal, ask for repair of the motor and handpiece.
Error code E4 appears.	After stopping to cool it down place for about 10 minutes, check the operation again.	If it operates normally, there is no problem. Check the operating environment, storage location, etc., for high temperature. If the same error code appears frequently, ask for repair of the unit.
	Vacuum-coupled Mode is on, while the dust collector is not used.	Make the Vacuum-coupled Mode to be off. See Vacuum-coupled Mode section in the manual.
Error code E5 appears.	Turn on the power again, and repeat starting and stopping several times.	If it operates normally, there is no problem. If the same error code appears, ask for repair of the unit.
Error code E6 appears.	The chuck is open.	Lock the chuck.
	Check turning a tip with a finger lightly and turning around it lightly.	If the rotation is abnormal, ask for repair of the motor and handpiece.
	Maintenance mode (3) "HL": Confirm whether you work by a motor signal check normally.	If any problem is found during a check, the motor cord may be severed or the sensor in the motor may be faulty. Ask for repair.
Error code E8 appears.	Turn on the power again.	Error indication is a temporary thing by the overload if I work normally. There is not it abnormally.
	If you have two or more units, replace the motor cord and check the operation.	If it operates normally after replacing the motor cord, the motor and/or the motor cord may be shorted. Ask for repair of the motor and/or the motor cord. If the same error code still appears after replacing the motor cord, ask for repair of the unit.

The motor and handpiece do not run, or Reset Lamp lights.

Trouble	Cause/Check	Remedy
The motor and handpiece do not run, or Reset Lamp lights.	Error code E9 appears.	If you have two or more units, replace the motor cord and check the operation. If it operates normally after replacing the motor cord, the motor and/or the motor cord may be shorted. Ask for repair of the motor and/or the motor cord. If the same error code still appears after replacing the motor cord, ask for repair of the unit.
	Error code EF appears.	Maintenance Mode (3) "Pd": Check whether Foot Pedal operates normally by Foot Pedal Chuck. If it does not operate normally, change the Foot Pedal for new or ask for repair.
The rotation speed does not rise.	The maximum rotation speed for operation by Foot Pedal should be set with the Speed Control Knob.	Check the connector of the turbine adapter, and re-insert it correctly.
The air turbine does not rotate.	The connector of the turbine adapter is disconnected.	Check the tube to the air line, and flow the air.
	The tube connected to the air line kit is bent or pinched.	Ask for repair of the turbine adapter and/or the Ultimate XL-K/D unit.
	The turbine adapter is faulty and/or the Ultimate XL-K/D is faulty.	Ask for repair of the turbine adapter and/or the Ultimate XL-K/D unit.

<Handpiece>

Trouble	Cause/Check	Remedy
The handpiece does not run with the chuck tightened.	Entry of foreign matter in the ball bearings or seizure.	Send it to your dealer. Ask for repair.
Heat is generated during rotation.	Entry of foreign matter in the ball bearings, causing wear of the bearings.	Same as the above.
Vibration or noise occurs during rotation.	Same as the above.	Same as the above.
	A bent bur is used.	Replace the bur.
Runout of the bur is heavy.	Dust may be stuck in the chuck or spindle.	Clean the inside of the chuck and spindle.
	The chuck is worn.	Replace the chuck.
	The ball bearings are worn.	Send it to your dealer.
The bur comes out	The chuck is loose.	Tighten the chuck securely. (See 12. Handling of Motor and Handpiece.)

16. Disposing Product

Please consult with dealer from whom you purchased it about waste disposal.